



# Product Manual

8 Channel Scanner  
with USB Data Logger

## MSU 1248U



**Multispan Control Instruments Pvt Ltd**

72/B, Phase 1, GIDC Estate, Vatva, Ahmedabad-382445, Gujarat, India.

☎ +91-79-40029250

☎ +91-9978991471

✉ [marketing@multispanindia.com](mailto:marketing@multispanindia.com)

🌐 [www.multispanindia.com](http://www.multispanindia.com)



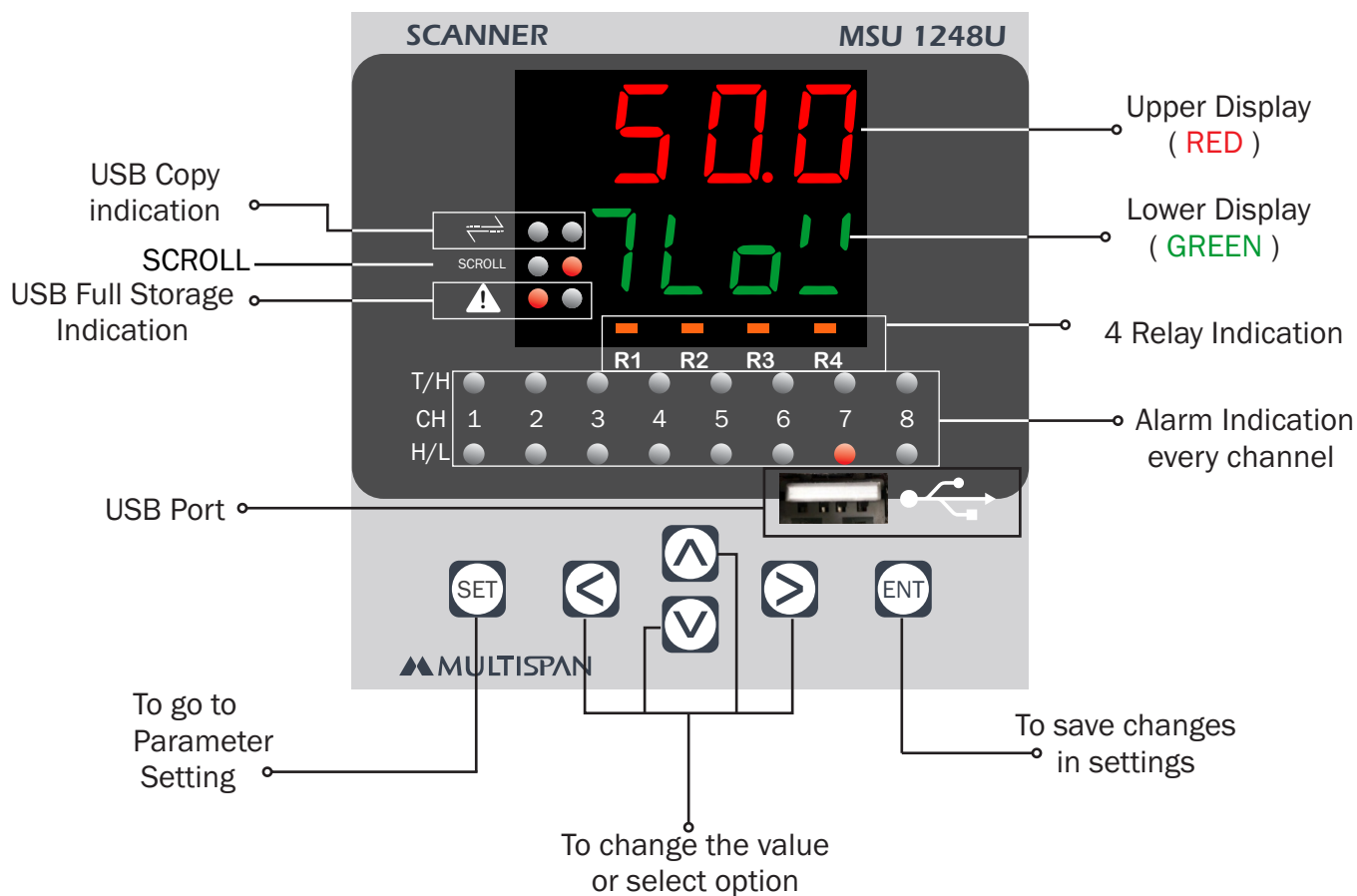





## Product Inception



## Technical Specifications

Model	MSU 1248U			
Display	UPPER: 4 Digit 7 seg 0.70", RED LED Display LOWER: 4 Digit 7 seg 0.50", GREEN LED Display			
Size (mm)	100 (H) X 100 (W) X 70 (D) mm			
Panel Cutout	92 X 92 mm			
Inputs and Range	<b>Thermocouple</b> J 0 to 600°C K 0 to 1200°C	<b>Analog input</b> 0 - 10V DC 0 - 20mA DC 4 - 20mA DC	<b>Range</b> } 999 To 9999	<b>RTD</b> PT-100/3W -99 to 400°C PT.1/3W -99.0 to 400.0°C
Output	4 Relay (NO-C-NC) 1C/O 5A@230V AC, 5A for resistive load USB Data Logging Facility			
Power Supply	100 to 270V AC, 50/60 Hz, Approx 4VA			
Operating Temperature	0°C To 55°C			
Relative Humidity	Up to 95% RH Non Condensing			

## Procedure

- 1) Do all connections as per the wiring diagram.  
To Configure: 1. Input Selection (J, K, PT-100, PT.1, 0 - 10V DC, 0 - 20mA DC & 4 - 20mA DC).
  2. Relay mode
    - If 1 Relay per group      ➤ If 2 Relay per group
    - LOW                              LOW / HIGH
    - HIGH                             HIGH / TRIP
    - HIGH / LOW
  - 3. Set point selection.
  - 4. Analog range selection .
  - 5. Offset and Correction factor selection.
  - 6. Communications parameter.
- 2) To add offset & correction factor, press  +  keys together.
  - Set offset for each channel if required.
  - Off set range will be  $\pm 25^{\circ}\text{C}$  for J, K, PT-100 temperature input.
  - Off set range will be  $\pm 25.0^{\circ}\text{C}$  for PT.1 temperature input.
  - Offset range will be -999 to 999 for analog input.
  - Correction factor range will be -999 to 999 **only for analog input.**
- 4) Press  key for 3 Sec to Change continuous scrolling or manual scrolling.
- 5) In Hold mode use  &  key to select next channel.
- 6) If  +  key is pressed then, display shows the TIME until key is pressed.
- 7) If  +  key is pressed then, display shows the Date until key is pressed.

## Terminal Diagram

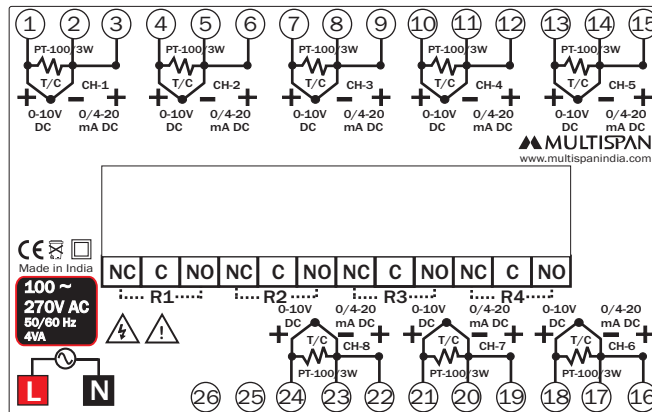

# Main Menu: To change set value & hysteresis based on relay mode & grouping



## For Example:

In Group No 1, If 1st channel, have a set point as a high alarm, 1 relay.

In Group No 2 If 2nd channel, have a set point as a low alarm, 1 relay.

For, 3rd, 4th, 5th, 6th, 7th, 8th channel have a set point as high & low alarm, 2 relay.

### MENU-1





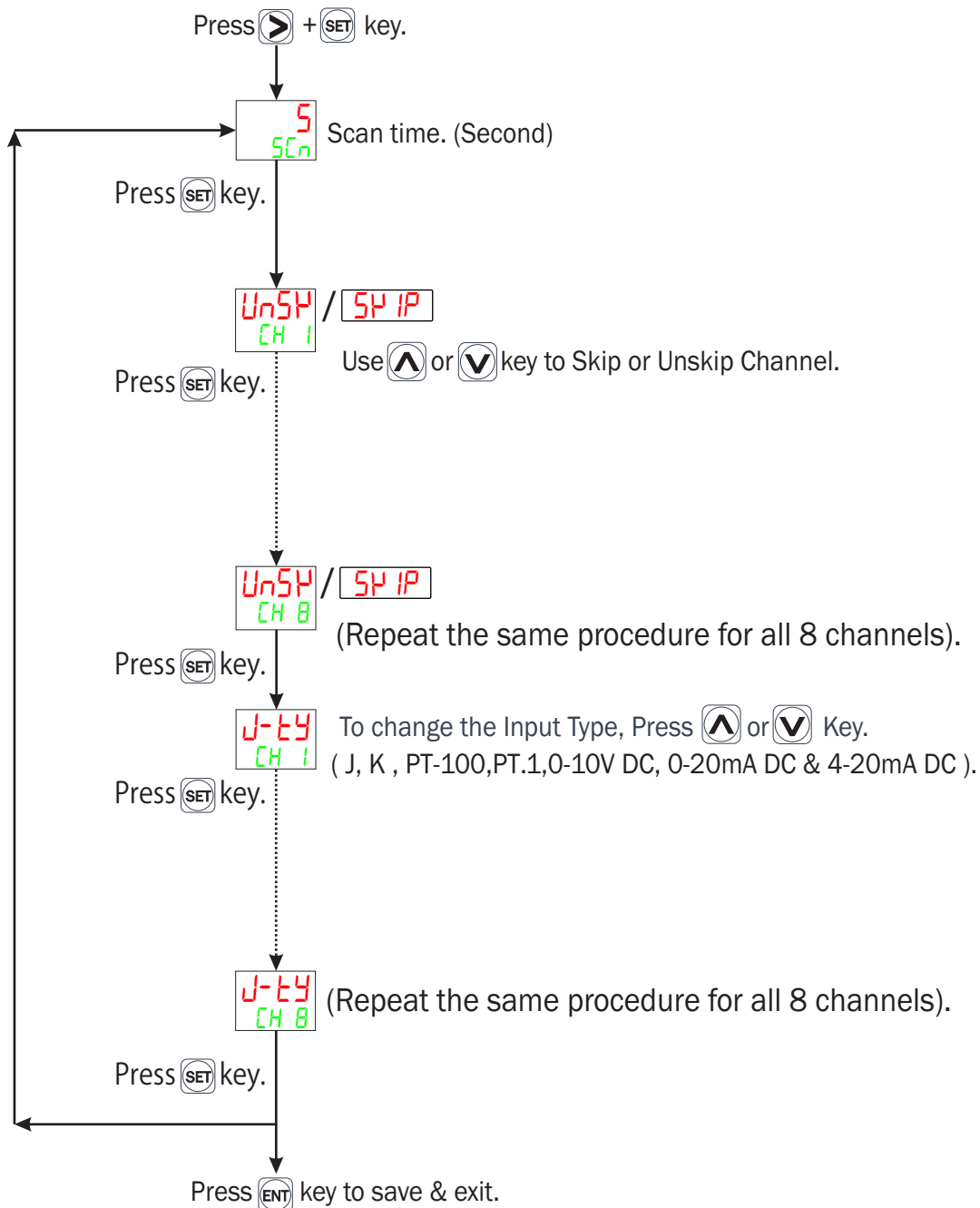





Note :- Values can be changed by pressing  or  keys.

### Input Selection



## Key Operation

Note :- Values can be changed by pressing  or  keys.

- 1) Press  key to enter in set value menu.
- 2) Press  &  Key to change the parameter setting.
- 3) Press  +  Key to enter in parameter menu (Input selection, skip-unskip selection)
- 4) Press  +  Key to enter in group menu for relay mode selection.
- 5) Press  +  Key to set OFFSET.
- 6) Press & hold  key to enter in scroll & hold mode.
- 7) Press  key for 3 Sec to Change continuous scrolling or manual scrolling.

## Menu: 2

To configurable no.of channel per group. (User can define maximum 4 group & maximum 8 channel/group), relay mode

### Relay menu

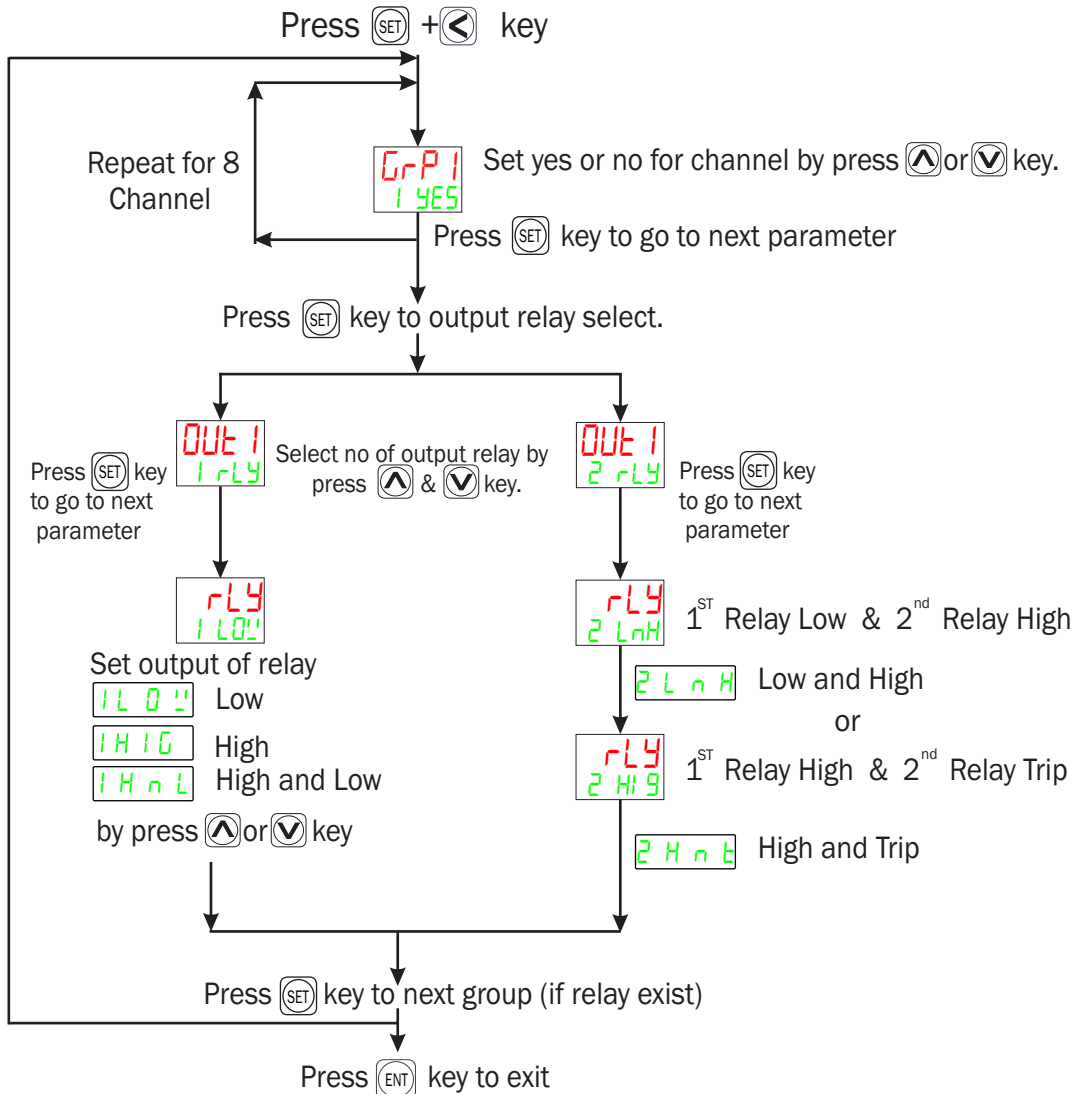

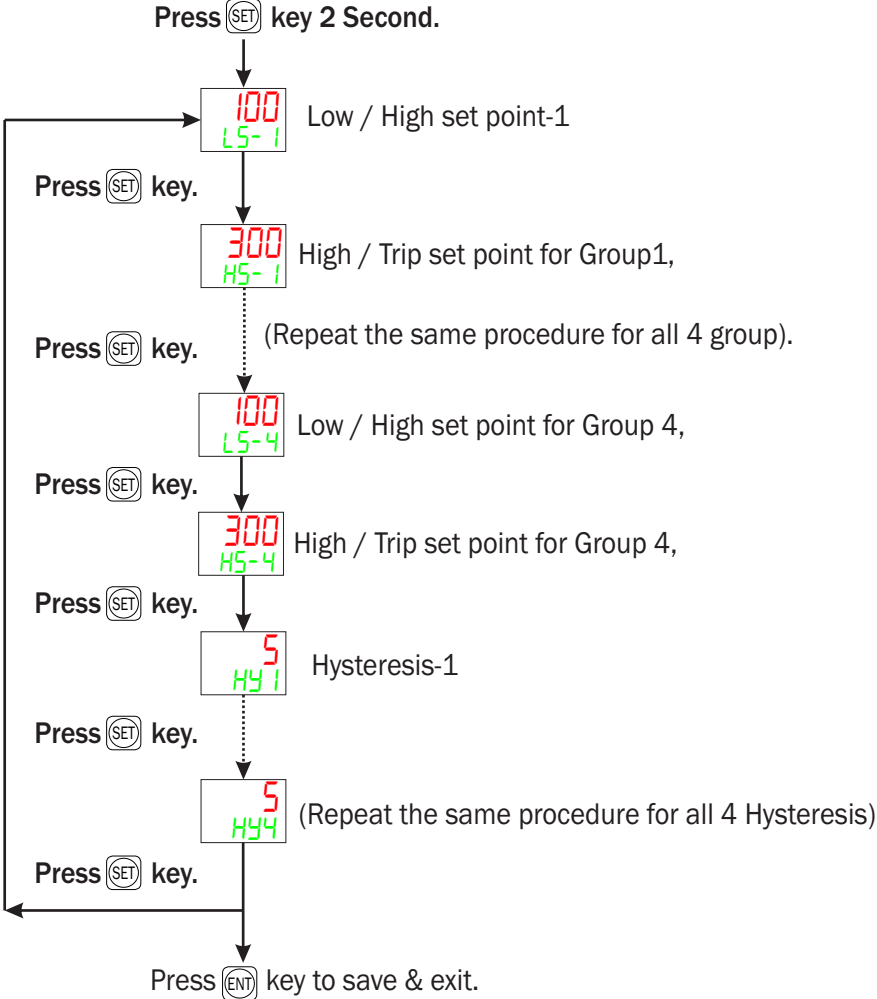

**MENU-3**

**Set point Selection**



## MENU-4

### Analog Range selection

Note :- Values can be changed by pressing  or  keys.

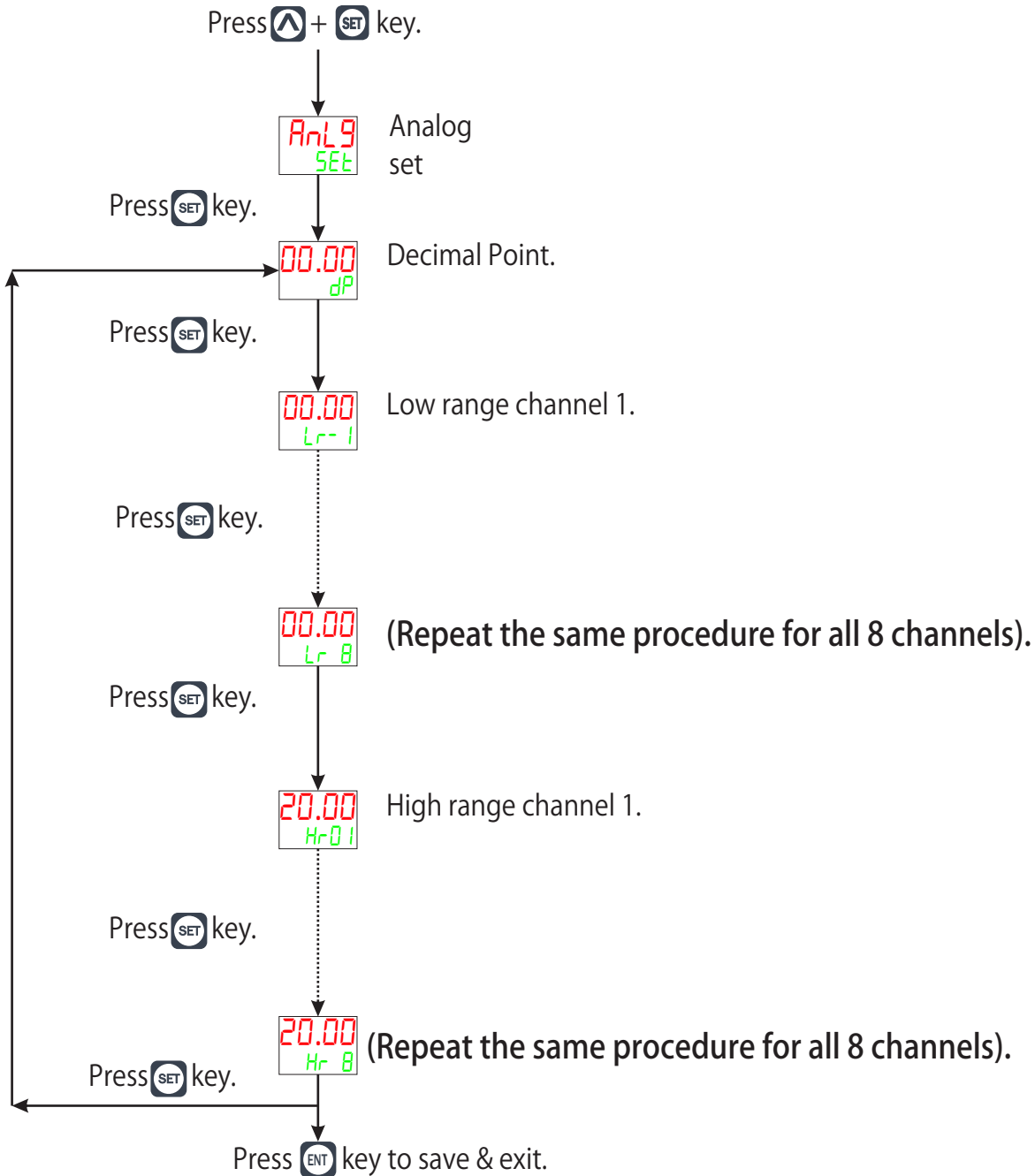

**NOTE:** DP (Decimal Point) is Common for all channels.  
Position can be changed by pressing  or  keys.

### Offset and Correction factor selection

Press  +  key to change offset.

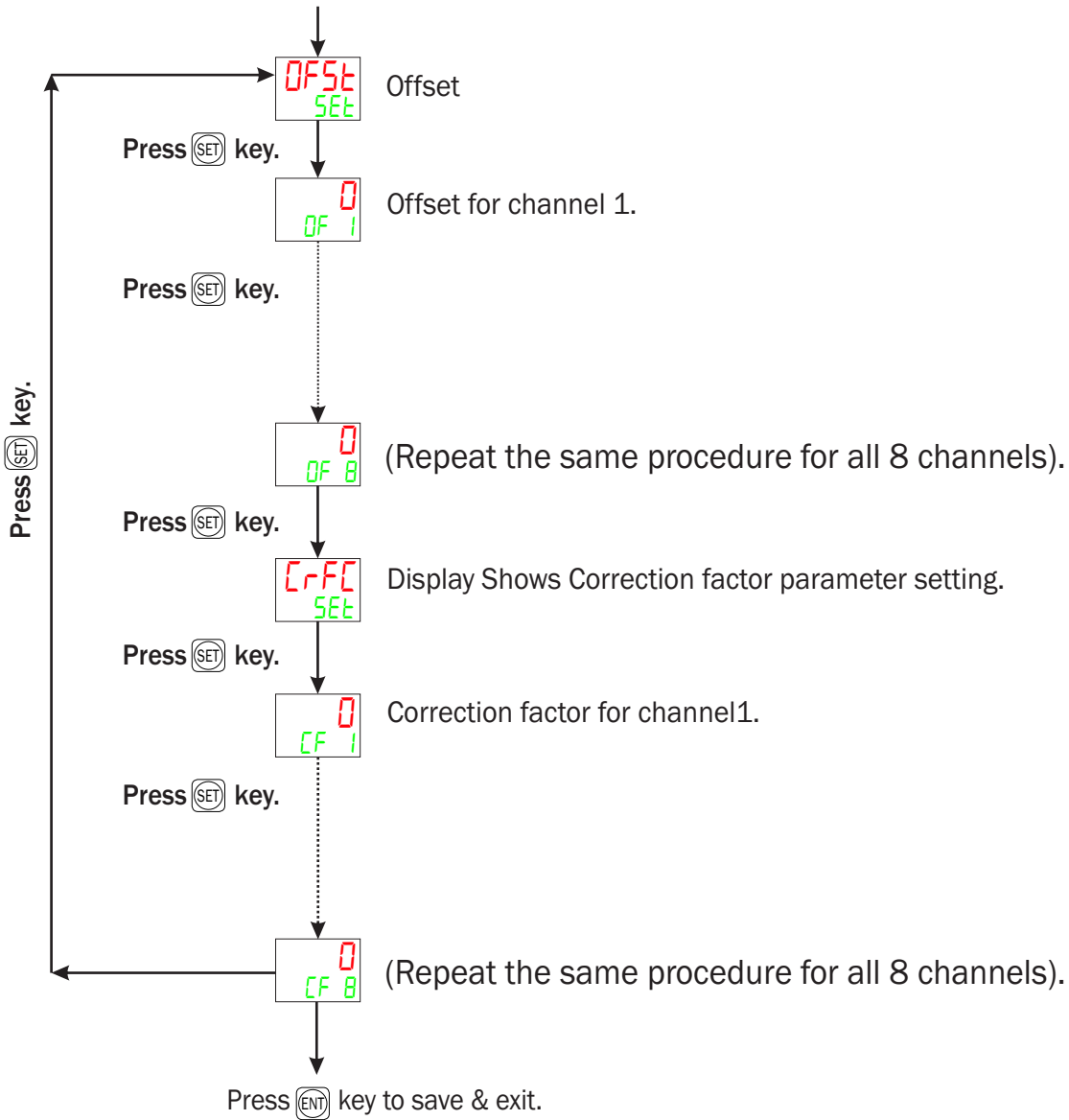



**Communication Parameter**

Note :- Values can be changed by pressing **▲** or **▼** keys.

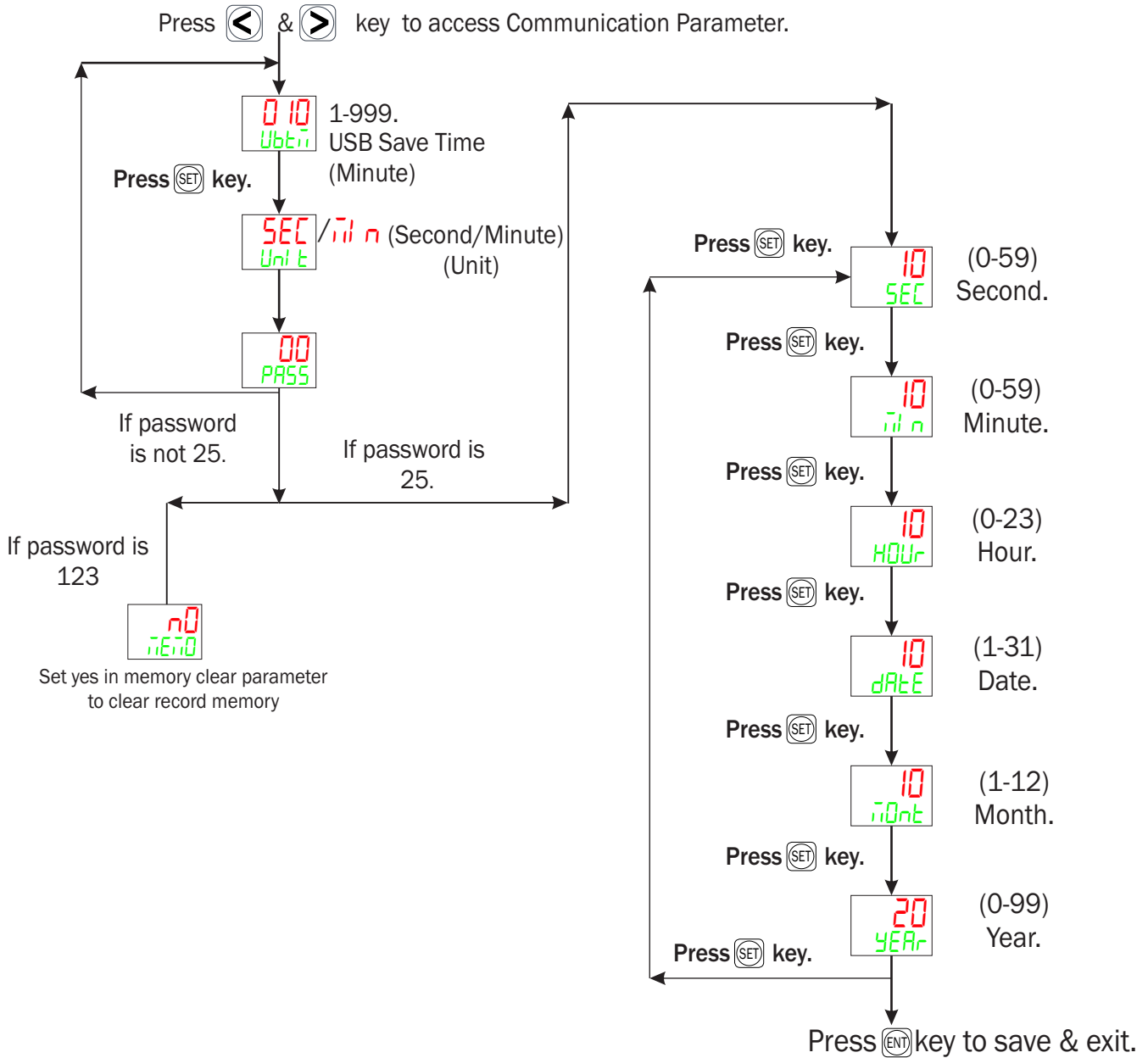

If usb is disable data won't be copy into memory

- 1) Press 3 Second **▶** + **▲** key to see time
- 2) Press 3 Second **▶** + **▼** key to see date
- 3) Press 3 Second **◀** key to see data record

## USB Excel Sheet Format

**Note :- Up to 8000 Values can be stored in internal memory, and after internal memory reaches to 6000 values Memory full indication LED start blinking which means memory is about to full.**

Date	Time	Channel 1	Channel 2	Channel 3	Channel 4	Channel 5	Channel 6	Channel 7	Channel 8
1/06/2020	14:22:00	45	42	39	35	35	35	35	33
1/06/2020	14:23:00	46	42	39	36	36	36	36	33
1/06/2020	14:24:00	46	42	39	36	36	36	36	34
1/06/2020	14:25:00	46	43	39	36	37	36	37	34
1/06/2020	14:26:00	46	43	39	36	37	36	37	34
1/06/2020	14:27:00	46	43	40	36	37	36	37	34
1/06/2020	14:28:00	46	43	40	37	37	37	37	34
1/06/2020	14:29:00	46	43	40	37	37	37	37	34
1/06/2020	14:30:00	46	43	40	37	37	37	37	34
		↓	↓	↓	↓	↓	↓	↓	↓
		↓	↓	↓	↓	↓	↓	↓	↓
		↓	↓	↓	↓	↓	↓	↓	↓
		↓	↓	↓	↓	↓	↓	↓	↓
		↓	↓	↓	↓	↓	↓	↓	↓
1/06/2020	14:40:00	46	43	40	37	37	37	37	34

# Mechanical Installation

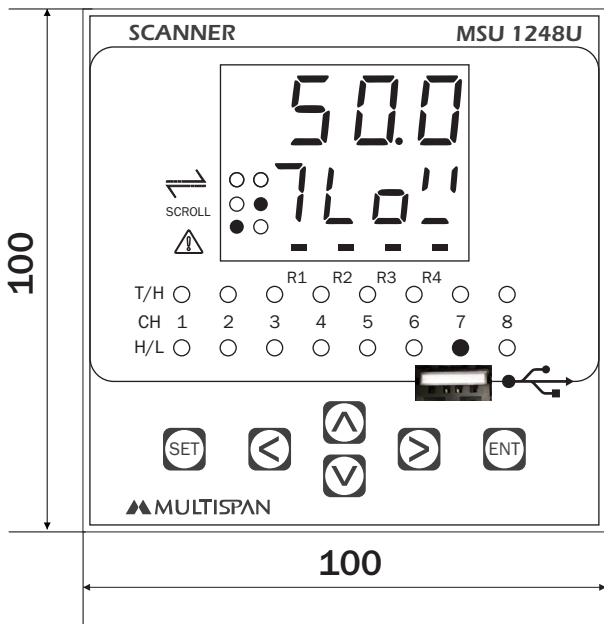

**FRONT VIEW**

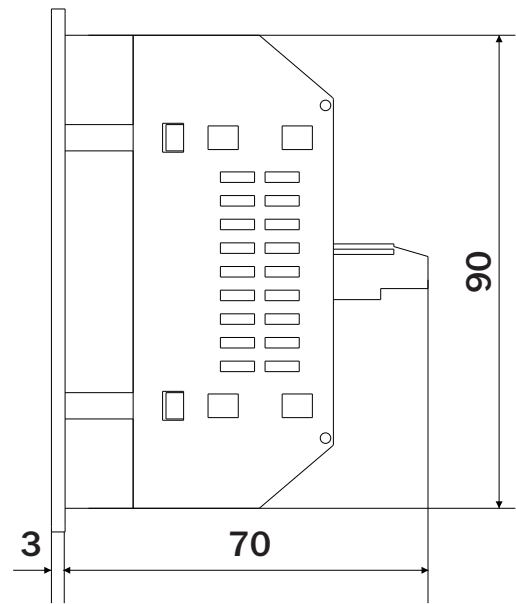

**RIGHT SIDE VIEW**

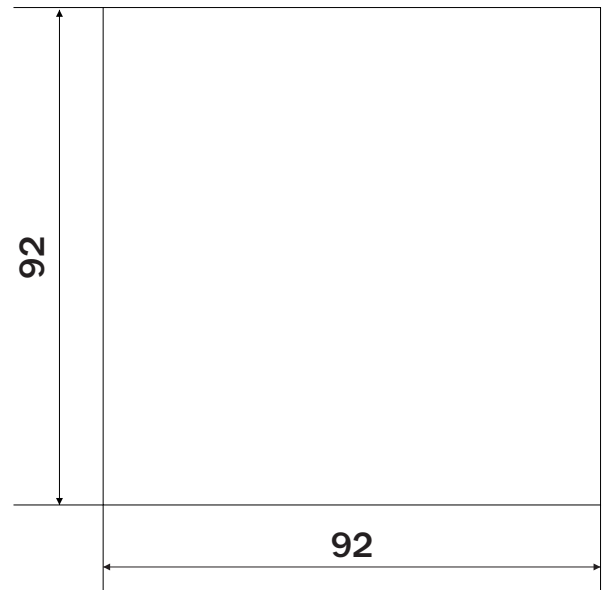

**Panel Cutout**

## Safety Precautions

All safety related codifications, symbols and instructions that appear in this operating manual or on the equipment must be strictly followed to ensure the safety of the operating personnel as well as the instrument.

If all the equipment is not handled in a manner specified by the manufacturer, it might impair the protection provided by the equipment .

=> Read complete instructions prior to installation and operation of the unit.



WARNING : Risk of electric shock.

## Warning Guidelines

- 1) To prevent the risk of electric shock power supply to the equipment must be kept OFF while doing the wiring arrangement. Do not touch the terminals while power is being supplied.
- 2) To reduce electro magnetic interference, use wire with adequate rating and twists of the same of equal size shall be made with shortest connection.
- 3) Cable used for connection to power source, must have a cross section of  $(1\text{mm})^2$  or greater. These wires should have insulations capacity made of at least 1.5kV.
- 4) When extending the thermocouple lead wires, always use thermocouple compensation wires for wiring for the RTD type, use a wiring material with a small lead resistance ( $5\Omega$  max per line) and no resistance differentials among three wires should be present.
- 5) A better anti-noise effect can be expected by using standard power supply cable for the instrument.

## Installation Guidelines

- 1) This equipment, being built-in-type, normally becomes a part of main control panel and in such case the terminals do not remain accessible to the end user after installation and internal wiring.
- 2) Do not allow pieces of metal, wire clippings, or fine metallic fillings from installation to enter the product or else it may lead to a safety hazard that may in turn endanger life or cause electrical shock to the operator.
- 3) Circuit breaker or mains switch must be installed between power source and supply terminal to facilitate power 'ON' or 'OFF' function. However this mains switch or circuit breaker must be installed at convenient place normally accessible to the operator.
- 4) Use and store the instrument within the specified ambient temperature and humidity ranges as mentioned in this manual.

## Mechanical Installation

- 1) Prepare the panel cutout with proper dimensions as show above.
- 2) Fit the unit into the panel with the help of clamp given.
- 3) The equipment in its installed state must not come in close proximity to any heating source, caustic vapors, oils steam, or other unwanted process by products.
- 4) Use the specified size of crimp terminal (M3.5 screws) to wire the terminal block. Tightening the screws on the terminal block using the tightening torque of the range of 1 N.m.
- 5) Do not connect anything to unused terminals.

## Maintenance

- 1) The equipment should be cleaned regularly to avoid blockage of ventilating parts.
- 2) Clean the equipment with a clean soft cloth. Do not use isopropyl alcohol or any other cleaning agent.
- 3) Fusible resistor must not be replaced by operator.

Product improvement and upgrade is a constant procedure. So for more updated operating information and support, Please contact our helpline : +91-9081078681 /9081078683 or Email at : [service@multispanindia.com](mailto:service@multispanindia.com) ver :- 2102